

Hy-Lok PS Series

Ball Valves and Fittings for Paint System

Catalog No. H - 100PS
Sep. 2006

General Information

Hy-Lok PS series valves & Fittings are designed smooth bore & minimum cavity-free and accurately manufactured so that and provide the convenience of effective performance for painting process and finishing work. Ball valve, fittings & accessory are also served.

■ Valves (See Page 2, 3)

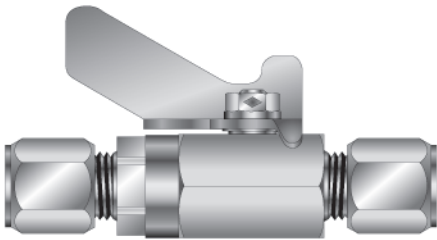

Materials of Construction

Body, Ball and End connection : SS316 Standards
Seat : PTFE
Handle : SS430 Standard
Others : Stainless General
● Body & Connection : Carbon steel Nickel plated as option

Silicon Free

To eliminate the enemy of contamination and the operate efficiently, silicon is free.

Pressure Rating (Max 40 bar; 600psig)

To deliver reliable fluid and air containment, working pressure rating meets 600psig

Special Plated nut threads

Hy-Lok Tube Fitting : Silver plated
Bite Type Tube Fitting : Dry lubricant
● Easy and positive ferrule set-up, without galling or annoying

Ordering Information

Add a material designator to the basic part number. ex.)BVPMB-6N6T / S316
Other body materials are available upon request.

■ Fittings (See Page 5)

Cavity Free

Due to no space to contain the painting dregs at inside of fittings cleaning process requires easy performance and minimum volume solvent

- No dead space.
- Smooth internal for easy cleaning
- Tube ends are machined with a square face and corners to enhance alignment and maintain tube wall uniformity.
- Weld Body
- Weld Nipple
- PTFE Packing
- Nut



HY-LOK CORPORATION

© 2006 HY-LOK CORPORATION All rights reserved



Male NPT to Male NPT

BVPM

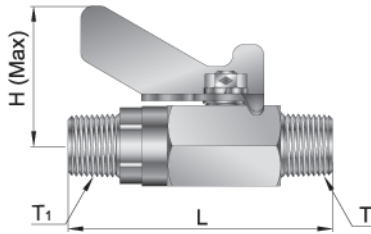

Basic Part Number	Connection		L		H	
	NPT T	NPT T ₁	mm	inch	mm	inch
BVPM-4N	1/4"	1/4"	72.5	2.85	37	1.46
BVPM-6N	3/8"	3/8"	73.0	2.87	37	1.46
BVPM-6N4N	3/8"	1/4"	73.0	2.87	37	1.46

Male NPSM to Male NPT

BVPM

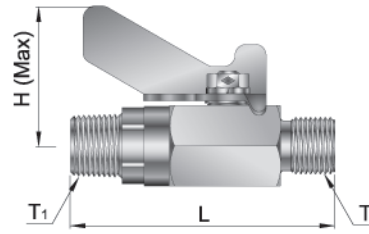

Basic Part Number	Connection		L		H	
	NPSM T	NPT T ₁	mm	inch	mm	inch
BVPM-6S4N	3/8"	1/4"	73	2.87	37	1.46
BVPM-6S6N	3/8"	3/8"	73	2.87	37	1.46

Male NPT to Female NPT

BVPMF

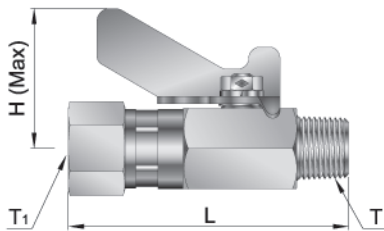

Basic Part Number	Connection		L		H	
	NPT T	NPT T ₁	mm	inch	mm	inch
BVPMF-6N	3/8"	3/8"	70.5	2.78	37	1.46

Male NPSM to Female NPT

BVPMF

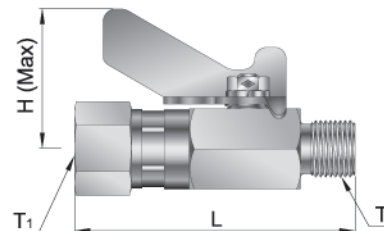

Basic Part Number	Connection		L		H	
	NPSM T	NPT T ₁	mm	inch	mm	inch
BVPMF-6S6N	3/8"	3/8"	70.5	2.78	37	1.46

Male NPT to Tube

BVPMB

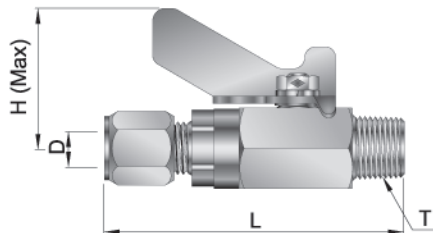

Basic Part Number	Connection		L		H	
	NPT T	Tube O.D. D	mm	inch	mm	inch
BVPMB-6N6T	3/8"	3/8"	82	3.23	37	1.46

Male NPSM to Tube

BVPMB

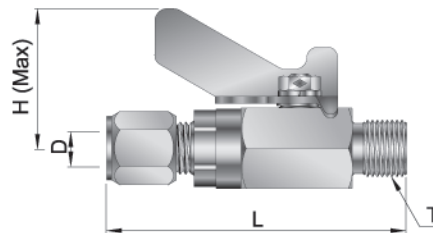

Basic Part Number	Connection		L		H	
	NPSM T	Tube O.D. D	mm	inch	mm	inch
BVPMB-6S6T	3/8"	3/8"	82	3.23	37	1.46
BVPMB-6S8T	3/8"	1/2"	88	3.47	37	1.46

Dimensions are reference only, subject to change.

Female NPT to Female NPT

BVPF

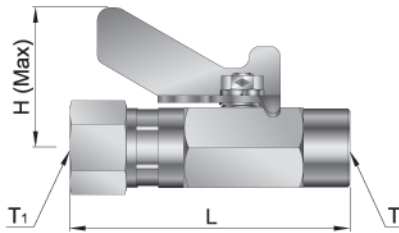

Basic Part Number	Connection		L		H	
	NPT T	NPT T ₁	mm	inch	mm	inch
BVPF-6N	3/8"	3/8"	70.5	2.78	37	1.46

Tube to Tube

BVPB

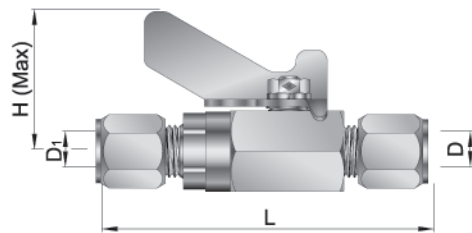

Basic Part Number	Connection		L		H	
	Tube O.D. D	Tube O.D. D ₁	mm	inch	mm	inch
BVPB-6T	3/8"	3/8"	90.0	3.54	37	1.46

Male NPSM to Tube Stub

BVPMT

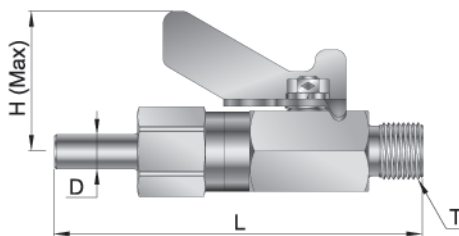

Basic Part Number	Connection		L		H	
	NPSM T	Tube O.D. D	mm	inch	mm	inch
BVPMT-6S6T	3/8"	3/8"	98.5	3.88	37	1.46

Tube to Tube Stub

BVPBT

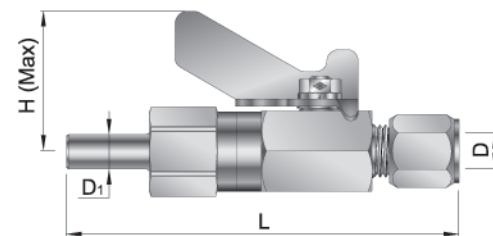

Basic Part Number	Connection		L		H	
	Tube O.D. D	Tube O.D. D ₁	mm	inch	mm	inch
BVPBT-6T	3/8"	3/8"	106.8	4.2	37	1.46

Male NPSM to Tube with BHD. Large Jam Nut

BVPMBBL

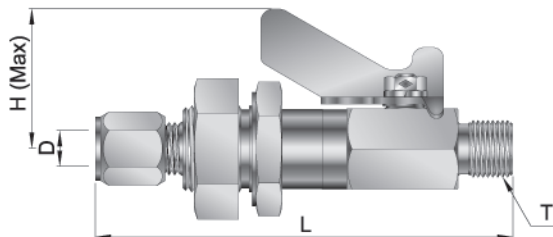

Basic Part Number	Connection		L		H	
	NPSM T	Tube O.D. D	mm	inch	mm	inch
BVPMBBL-6S6T	3/8"	3/8"	113.5	4.47	37	1.46
BVPMBBL-6S8T	3/8"	1/2"	113.5	4.47	37	1.46

Male NPSM to Tube with BHD. Small Jam Nut

BVPMBBS

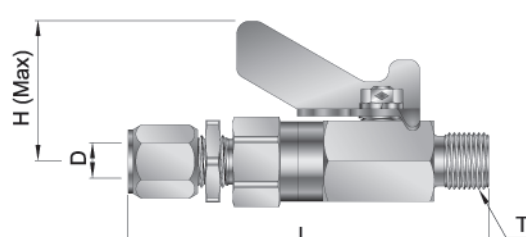

Basic Part Number	Connection		L		H	
	NPSM T	Tube O.D. D	mm	inch	mm	inch
BVPMBBS-6S6T	3/8"	3/8"	97.8	3.85	37	1.46

Dimensions are reference only, subject to change.

Hose Swivel Connector
HPSMC

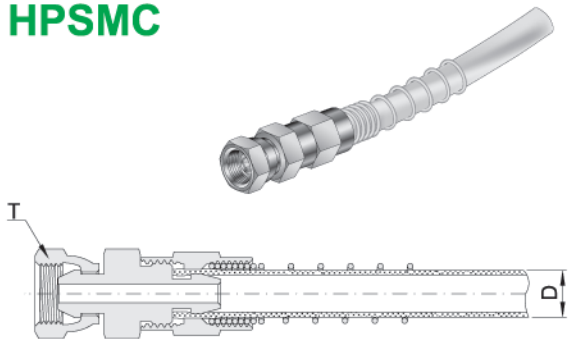

Basic Part Number	Connection	
	Tube O.D. D	T (BSP/PF)
HPSMC 6M-03G	6mm	3/8"
HPSMC 8M-02G	8mm	1/4"
HPSMC10M-02G	10mm	1/4"
HPSMC12M-02G	12mm	1/4"
HPSMC12M-03G	12mm	3/8"
HPSMC81-02G	6A	1/4"
HPSMC81-03G	6A	3/8"

Hose Male Connector
HPFU

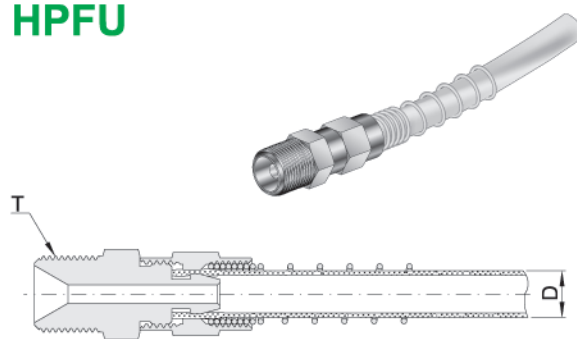

Basic Part Number	Connection	
	D	T (NPSM)
HPFU6M-03S	6mm	3/8"
HPFU81-03S	6A	3/8"

Special Tee
ST

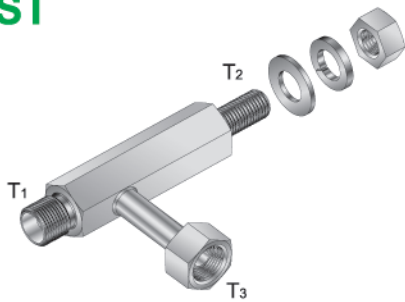

Basic Part Number	Connection		
	T ₁	Mounting T ₂	T ₃
ST03SM1203G	NPSM 3/8	M12	PF 3/8
ST03SM1203S	NPSM 3/8	M12	NPSM 3/8

Special Tee
HT

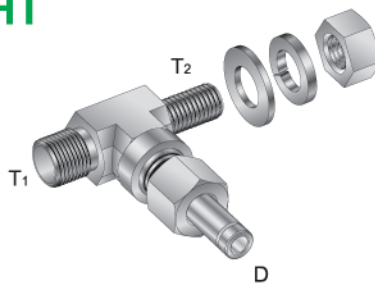

Basic Part Number	Connection		
	T ₁	Mounting T ₂	Tube O.D. D
HT03S-M12-10	NPSM 3/8	M12	10mm
HT03S-M12-6T	NPSM 3/8	M12	3/8"

Y-Connector
HPSYC

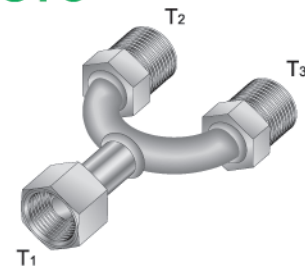

Basic Part Number	Connection		
	T ₁	T ₂	T ₃
HPSYC03G-03G	PF 3/8	PF 3/8	PF 3/8
HPSYC03G-02G	PF 3/8	PF 1/4	PF 1/4

Female Hose Swivel to Male Connector
HPSMCM

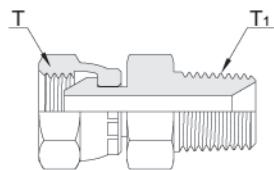

Basic Part Number	Connection	
	T	T ₁
HPSMCM-0303R	PF 3/8	PT 3/8
HPSMCM-0303N	PF 3/8	NPT 3/8

Male Hose Swivel to Male Elbow
HPSMAM

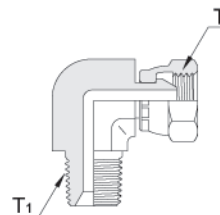

Basic Part Number	Connection	
	T	T ₁
HPSMAM-0303R	PF 3/8	PT 3/8
HPSMAM-0303N	PF 3/8	NPT 3/8

Dimensions are reference only, subject to change.

Buttweld to Buttweld PSUNBW

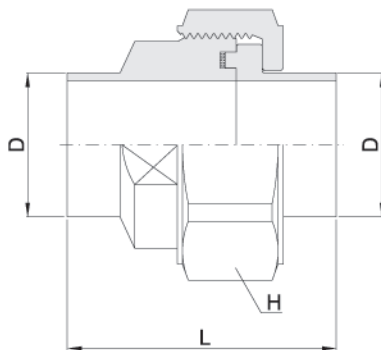

Basic Part Number	O.D	Width across flat	L
	D	HEX.	
PSUNBW19M-19M	19.0	34.9	48.5
PSUNBW23M-23M	23.0	41.0	50.0
PSUNBW27M-27M	27.2	46.0	50.8
PSUNBW29M-29M	29.0	46.0	51.0
PSUNBW34M-34M	34.0	50.0	52.0
PSUNBW41M-41M	41.0	60.0	62.0
PSUNBW53M-53M	53.0	75.0	65.0

Taper Thread to Buttweld PSUNBW

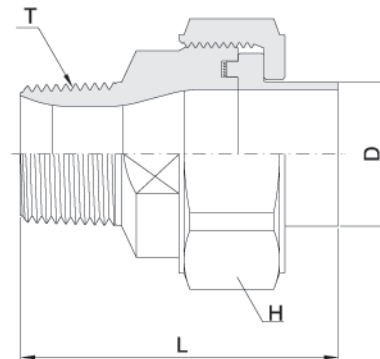

Basic Part Number	O.D	Width across flat	T (NPT)	L
	D	HEX.		
PSUNBW04N-19M	19.0	34.9	1/2	57.5
PSUNBW04N-23M	23.0	41.0	1/2	59.0
PSUNBW06N-27M	27.2	46.0	3/4	60.0
PSUNBW06N-29M	29.0	46.0	3/4	60.0
PSUNBW08N-34M	34.0	50.0	1	65.0
PSUNBW10N-41M	41.0	60.0	1 1/4	75.0
PSUNBW12N-53M	53.0	75.0	1 1/2	78.0

Parallel Thread to Buttweld PSUNBW

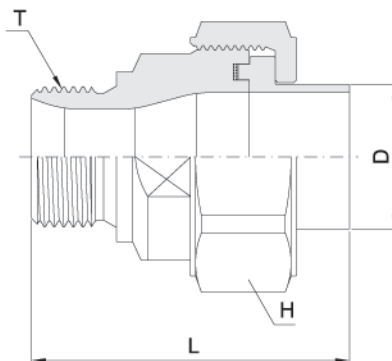

Basic Part Number	O.D	Width across flat	T (PF)	L
	D	HEX.		
PSUNBW04G-19M	19.0	34.9	1/2	57.5
PSUNBW04G-23M	23.0	41.0	1/2	59.0
PSUNBW06G-27M	27.2	46.0	3/4	60.0
PSUNBW06G-29M	29.0	46.0	3/4	60.0
PSUNBW08G-34M	34.0	50.0	1	65.0
PSUNBW10G-41M	41.0	60.0	1 1/4	75.0
PSUNBW12G-53M	53.0	75.0	1 1/2	78.0

Packing PSBWG



Basic Part Number	d	D	L
PSBWG20M-25M	20	25	1.5
PSBWG31M-25M	25	31	1.5
PSBWG35M-29M	29	35	1.5
PSBWG38M-32M	32	38	1.5
PSBWG49M-43M	43	49	1.5
PSBWG62M-56M	56	62	1.5
PSUNBW53M-53M	53	75	65.0

Dimensions are reference only, subject to change.

Tee Type Reducing Union

BUT-R

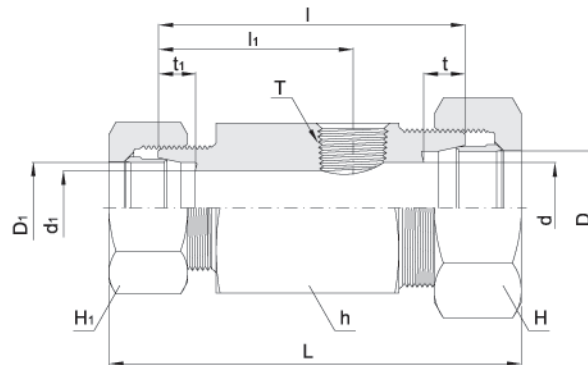

Basic Part Number	Tube O.D		(PT) T	*d	*d ₁	Width across flat			t	t ₁	l ₁	l	Approx L
	D	D ₁				h	H	H ₁					
BUT08-03R	8	8	3/8	6	6	36	17	17	7.0	7.0	45	68	89.0
BUT10-08-03R	10	8	3/8	8	6	36	19	17	7.0	7.0	45	68	90.0
BUT10-03R	10	10	3/8	8	8	36	19	19	7.0	7.0	45	68	91.0
BUT12-08-03R	12	8	3/8	10	6	36	22	17	7.0	7.0	45	68	90.0
BUT12-10-03R	12	10	3/8	10	8	36	22	19	7.0	7.0	45	68	91.0
BUT12-03R	12	12	3/8	10	10	36	22	22	7.0	7.0	45	68	91.0
BUT15-10-03R	15	10	3/8	13	8	36	27	19	7.5	7.0	45	70	94.0
BUT15-12-03R	15	12	3/8	13	10	36	27	22	7.5	7.0	45	70	94.0
BUT15-03R	15	15	3/8	13	13	36	27	27	7.5	7.5	47	72	97.0
BUT16-03R	16	16	3/8	14	14	36	30	30	7.5	7.5	47	72	97.0
BUT18-12-03R	18	12	3/8	16	10	36	32	22	8.0	7.0	45	70	94.0
BUT18-15-03R	18	15	3/8	16	13	36	32	27	8.0	7.5	47	72	97.0
BUT18-03R	18	18	3/8	16	16	36	32	32	8.0	8.0	47	72	97.0
BUT20-12-03R	20	12	3/8	17	10	36	36	22	9.0	7.0	45	70	94.0
BUT20-16-03R	20	16	3/8	17	14	36	36	30	10.0	7.5	47	72	97.0
BUT20-18-03R	20	18	3/8	17	16	41	36	32	10.0	8.0	47	72	97.0
BUT20-03R	20	20	3/8	17	17	36	36	36	8.0	8.0	47	72	97.0
BUT22-15-03R	22	15	3/8	19	13	41	36	27	10.0	7.5	47	72	97.0
BUT22-18-03R	22	19	3/8	19	16	46	36	32	11.0	8.0	47	72	97.0
BUT22-20-03R	22	20	3/8	19	17	36	36	36	7.0	8.0	47	72	97.0
BUT22-03R	22	22	3/8	19	19	36	36	36	9.0	9.0	47	72	97.0
BUT25-16-03R	25	16	3/8	22	14	36	41	30	7.0	7.5	47	74	100.0
BUT25-20-03R	25	20	3/8	22	17	36	41	36	7.0	8.0	47	74	100.0
BUT25-22-03R	25	22	3/8	22	19	36	41	36	7.5	9.0	47	74	100.0
BUT25-03R	25	25	3/8	22	22	36	41	41	10.0	10.0	47	74	101.0
BUT28-18-03R	28	18	3/8	25	16	41	46	32	7.5	8.0	47	74	100.5
BUT28-22-03R	28	22	3/8	25	19	41	46	36	8.0	9.0	47	74	100.5
BUT28-25-03R	28	25	3/8	25	22	41	46	41	8.0	10.0	47	74	101.5
BUT28-03R	28	28	3/8	25	25	41	46	46	10.0	10.0	49	76	104.0
BUT30-20-03R	30	20	3/8	27	17	41	46	36	9.0	8.0	47	74	101.0
BUT30-25-03R	30	25	3/8	27	22	41	46	41	10.0	10.0	47	74	102.0
BUT30-28-03R	30	28	3/8	27	25	41	46	46	10.0	10.0	49	76	104.5
BUT30-03R	30	30	3/8	27	27	41	46	46	10.0	10.0	49	76	105.0
BUT86-22-03R	34	22	3/8	30	19	46	55	36	10.0	9.0	47	74	104.0
BUT86-28-03R	34	28	3/8	30	25	46	55	46	11.0	10.0	49	76	107.5
BUT86-03R	34	34	3/8	30	30	46	55	55	11.0	11.0	49	76	111.0

* Part 'd' can be changed according to buyer's tube specification. Assembly instruction refers to the catalog number H-220TF.

Dimensions are reference only, subject to change.

Tee Type Reducing Union

BUTSW

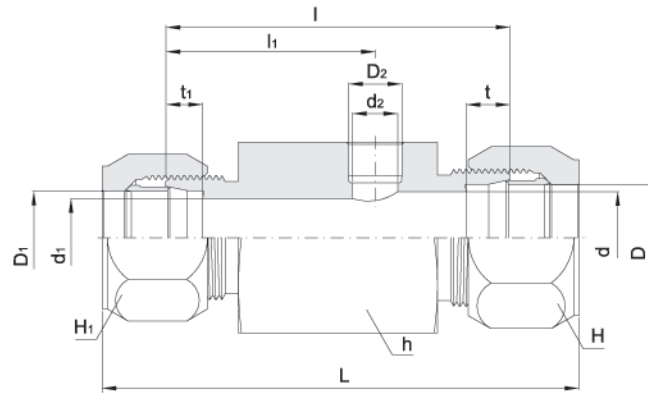
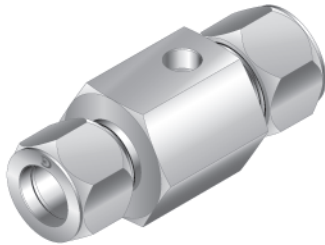

Basic Part Number	Tube O.D			*d	*d ₁	*d ₂	Width across flat			t	t ₁	l ₁	l	Approx L
	D	D ₁	D ₂				h	H	H ₁					
BUTSW12T-6T	19.1	19.10	9.53	15.8	15.8	7.7	36	31.7	31.7	8.89	8.89	50.5	83.0	111.4
BUTSW14T-6T	22.2	22.20	9.53	19.3	19.3	7.7	36	34.9	34.9	8.89	8.89	50.5	83.0	110.0
BUTSW16T-6T	25.4	25.40	9.53	22.1	22.1	7.7	36	38.1	38.1	10.54	10.54	50.5	83.0	116.6
BUTSW20T-6T	31.8	31.80	9.53	27.5	27.5	7.7	46	50.8	50.8	10.54	10.54	50.5	83.0	119.6
BUTSW20T-8T	31.8	31.80	12.7	27.5	27.5	10.9	50	50.8	50.8	10.54	10.54	50.5	83.0	119.6
BUTSW24T-6T	38.1	38.10	9.53	33.9	33.9	7.7	50	57.1	57.1	12.32	12.32	50.5	83.0	119.6
BUTSW8T-6T-6T	12.7	9.53	9.53	10.9	7.7	7.7	36	22.2	17.4	7.75	6.35	45.0	74.0	98.6
BUTSW10T-6T-6T	15.8	9.53	9.53	13.4	7.7	7.7	36	25.4	17.4	8.89	6.35	45.0	75.0	100.4
BUTSW10T-8T-6T	15.8	12.70	9.53	13.4	10.9	7.7	36	25.4	22.2	8.89	7.75	48.2	78.2	104.4
BUTSW12T-10T-6T	19.1	15.80	9.53	15.8	13.4	7.7	36	31.7	25.4	8.89	8.89	49.0	82.0	109.7
BUTSW14T-12T-6T	22.2	19.05	9.53	19.3	15.8	7.7	36	34.9	31.7	8.89	8.89	50.5	83.0	110.7
BUTSW16T-14T-6T	25.4	22.20	9.53	22.1	19.3	7.7	36	38.1	34.9	10.54	8.89	50.5	83.0	113.3
BUTSW20T-16T-6T	31.8	25.40	9.53	27.5	22.1	7.7	46	50.8	38.1	10.54	10.54	50.5	83.0	118.1
BUTSW24T-20T-6T	38.1	25.40	9.53	33.9	27.5	7.7	50	57.1	50.8	12.32	10.54	50.5	83.0	119.6

* Part 'd' can be changed according to buyer's tube specification.
 Assembly instruction refers to the catalog number H-220TF.

Dimensions are reference only, subject to change.

Tee Type Reducing Union

BUT

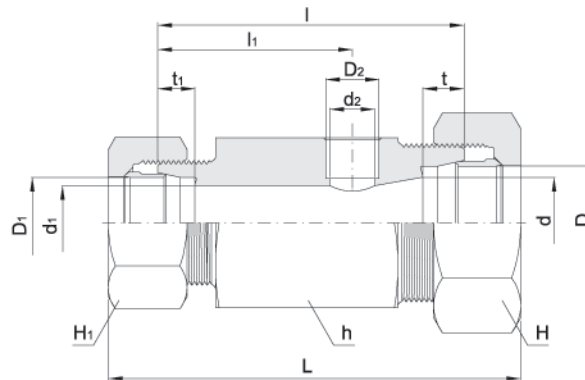

Basic Part Number	Tube O.D			*d	*d ₁	*d ₂	Width across flat			t	t ₁	l ₁	l	Approx L
	D	D ₁	D ₂				h	H	H ₁					
BUT12-10-10	12	10	10	10	8.0	8.0	24	22	19	7.0	7.0	28	79	72.0
BUT15-12-10	15	12	10	13	10.0	8.0	24	27	22	7.5	7.0	30	51	75.0
BUT15-12-12	15	12	12	13	10.0	10.0	27	27	22	7.5	7.0	30	51	75.0
BUT15-12-14	15	12	14	12	10.0	10.0	30	27	22	7.5	7.0	33	56	80.0
BUT18-15-10	18	15	10	16	13.0	8.0	30	32	27	8.0	7.5	33	58	83.0
BUT18-15-12	18	15	12	16	13.0	10.0	30	32	27	8.0	7.5	33	58	83.0
BUT18-15-14	18	15	14	15	12.0	10.0	30	32	27	8.0	7.5	33	58	83.0
BUT20-15-14	20	15	14	17	12.0	10.0	32	36	32	8.0	7.5	34	58	83.0
BUT20-18-10	20	18	10	18	16.0	8.0	32	36	32	8.0	7.5	35	58	83.0
BUT20-18-12	20	18	12	18	16.0	10.0	32	36	32	8.0	8.0	34	58	83.0
BUT20-18-14	20	18	14	17	15.0	10.0	32	36	32	8.0	8.0	34	58	83.0
BUT20-10	20	20	10	18	18.0	8.0	32	36	36	8.0	8.0	34	58	83.0
BUT22-20-10	22	20	10	20	18.0	8.0	36	36	36	8.0	8.0	34	58	83.0
BUT22-20-12	22	20	12	19	17.0	10.0	36	36	36	9.0	8.0	35	58	83.0
BUT22-20-14	22	20	14	19	17.0	10.0	36	36	36	9.0	8.0	35	58	83.0
BUT25-20-14	25	20	14	22	17.0	10.0	36	41	36	9.0	8.0	35	58	83.0
BUT25-22-10	25	22	10	22	20.0	8.0	36	41	36	10.0	8.0	35	63	89.0
BUT25-22-12	25	22	12	22	20.0	10.0	36	41	36	10.0	9.0	35	63	89.0
BUT25-22-14	25	22	14	22	20.0	10.0	36	41	41	10.0	9.0	35	63	89.0
BUT25-14	25	25	14	22	22.0	10.0	36	41	41	10.0	9.0	35	63	90.0
BUT28-25-10	28	25	10	25	22.0	8.0	41	46	41	10.0	10.0	35	63	92.5
BUT28-25-12	28	25	12	25	7.7	7.7	41	46	46	10.0	10.0	39	65	92.5
BUT28-10	28	28	10	25	25.0	8.0	41	46	46	10.0	10.0	39	67	95.0
BUT30-28-10	30	28	10	27	25.0	8.0	41	46	46	10.0	10.0	39	67	95.5
BUT30-28-12	30	28	12	27	25.0	10.0	41	46	46	10.0	10.0	38	67	95.5
BUT30-10	30	30	10	27	27.0	8.0	41	46	46	10.0	10.0	38	67	96.0
BUT86-30-12	34	30	12	30	27.0	10.0	46	55	46	11.0	10.0	41	67	99.0
BUT86-10	34	34	10	30	30.0	8.0	46	55	55	11.0	11.0	41	67	102.0

* Part 'd' can be changed according to buyer's tube specification.
 Assembly instruction refers to the catalog number H-220TF.

Dimensions are reference only, subject to change.

Reducing Tee

BTR

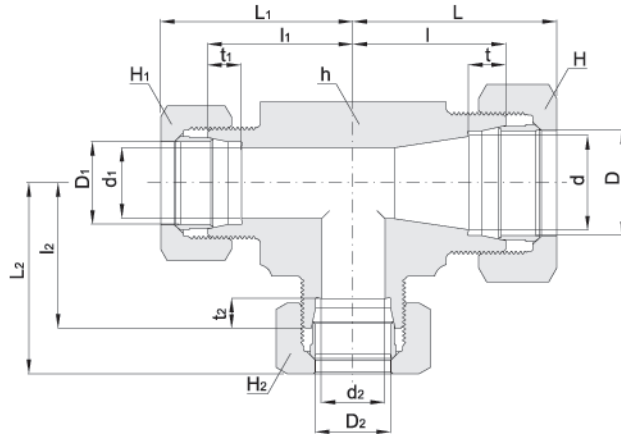

Basic Part Number	Tube O.D			*d	*d ₁	*d ₂	Width across flat				t	t ₁	t ₂	l	l ₁	l ₂	Approx		
	D	D ₁	D ₂				h	H	H ₁	H ₂							L	L ₁	L ₂
BTR08A08A10A	8	8	10	6	6	8	17	17	17	19	7.0	7.0	7.0	23	23	23	33.5	33.5	34.5
BTR10A10A08A	10	10	8	8	8	6	17	19	19	17	7.0	7.0	7.0	23	23	23	34.5	34.5	33.5
BTR08A08A12A	8	8	12	6	6	10	19	17	17	22	7.0	7.0	7.0	24	24	24	34.5	34.5	35.5
BTR12A08A08A	12	8	8	10	6	6	19	22	17	17	7.0	7.0	7.0	24	24	24	35.5	34.5	34.5
BTR12A12A08A	12	12	8	10	10	6	19	22	22	17	7.0	7.0	7.0	24	24	24	35.5	35.5	34.5
BTR12A10A10A	12	10	10	10	8	8	19	22	19	19	7.0	7.0	7.0	24	24	24	35.5	35.5	35.5
BTR12A12A10A	12	12	10	10	10	8	19	22	22	19	7.0	7.0	7.0	24	24	24	35.5	35.5	35.5
BTR12A10A12A	12	10	12	10	8	10	19	22	19	22	7.0	7.0	7.5	24	24	24	35.5	35.5	35.5
BTR10A10A15A	10	10	15	8	8	13	24	19	19	27	7.0	7.0	7.5	27	27	29	38.5	38.5	41.5
BTR12A12A15A	12	12	15	10	10	13	24	22	22	27	7.0	7.0	7.5	27	27	29	38.5	38.5	41.5
BTR15A15A10A	15	15	10	13	13	8	24	27	27	19	7.5	7.5	7.0	29	29	27	41.5	41.5	38.5
BTR15A15A12A	15	15	12	13	13	10	24	27	22	22	7.5	7.0	7.0	29	27	27	41.5	38.5	38.5
BTR15A15A12A	15	15	12	13	13	10	24	27	27	22	7.5	7.5	7.0	29	29	27	41.5	41.5	38.5
BTR15A12A15A	15	12	15	13	10	13	24	27	22	27	7.5	7.0	7.5	29	27	29	41.5	38.5	41.5
BTR12A12A16A	12	12	15	10	10	13	27	22	22	30	7.0	7.0	7.5	30	30	32	41.5	41.5	44.5
BTR16A16A08A	16	16	8	14	14	6	27	30	30	17	7.5	7.5	7.0	32	32	30	44.5	44.5	40.5
BTR16A16A10A	16	16	10	14	14	8	27	30	30	19	7.5	7.5	7.0	32	32	30	44.5	44.5	41.5
BTR16A16A12A	16	16	12	14	14	10	27	30	30	22	7.5	7.5	7.0	32	32	30	44.5	44.5	41.5
BTR12A12A18A	12	12	18	10	10	16	27	22	22	32	7.0	7.0	8.0	30	30	32	41.5	41.5	44.5
BTR18A10A10A	18	10	10	16	8	8	27	32	19	19	8.0	7.0	7.0	32	30	30	44.5	41.5	41.5
BTR18A18A10A	18	18	10	16	16	8	27	32	32	19	8.0	8.0	7.0	32	32	30	44.5	44.5	41.5
BTR18A18A12A	18	18	12	16	16	10	27	32	32	22	8.0	8.0	7.0	32	32	30	44.5	44.5	41.5
BTR18A18A15A	18	18	15	16	16	13	27	32	32	27	8.0	8.0	7.5	32	32	32	44.5	44.5	41.5
BTR18A10A18A	18	10	18	16	8	16	27	32	19	32	8.0	7.0	8.0	32	30	32	44.5	41.5	44.5
BTR16A16A20B	16	16	20	14	14	18	30	30	30	36	7.5	7.5	8.0	33	33	33	45.5	45.5	45.5

Tube Wall Thickness

A = 1.0t

B = 1.5t

C = 2.0t

* Part 'd' can be changed according to buyer's tube specification.
 Assembly instruction refers to the catalog number H-220TF.

Dimensions are reference only, subject to change.

Reducing Tee

BTR

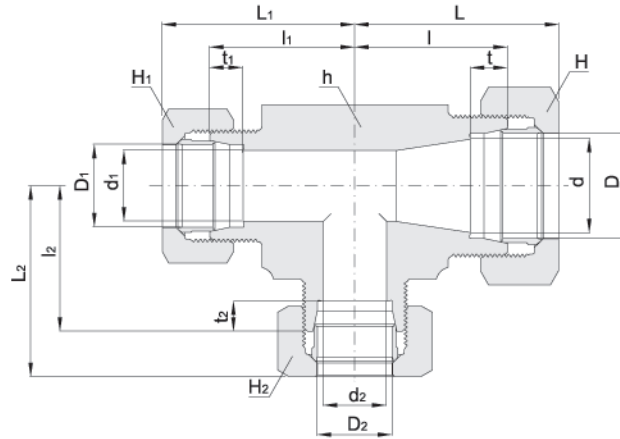

Basic Part Number	Tube O.D			*d	*d ₁	*d ₂	Width across flat				t	t ₁	t ₂	l	l ₁	l ₂	Approx		
	D	D ₁	D ₂				h	H	H ₁	H ₂							L	L ₁	L ₂
BTR20B20B10A	20	20	10	17	17	8	30	36	36	19	8	8.0	7.0	33	33	31	45.5	45.5	42.5
BTR20B20B12A	20	20	12	17	17	10	30	36	36	22	8	8.0	7.0	33	33	31	45.5	45.5	42.5
BTR20B20B16A	20	20	16	17	17	14	30	36	36	30	8	8.0	7.5	33	33	33	45.5	45.5	45.5
BTR22B22B10A	22	22	10	19	19	8	32	36	36	19	9	9.0	7.0	34	34	32	46.5	46.5	43.5
BTR22B22B12A	22	22	12	19	19	10	32	36	36	22	9	9.0	7.0	34	34	32	46.5	46.5	43.5
BTR22B15A15A	22	15	15	19	13	13	32	36	27	27	9	7.5	7.5	34	34	34	46.5	46.5	46.5
BTR22B22B15A	22	22	15	19	19	13	32	36	36	27	9	9.0	7.5	34	34	34	46.5	46.5	46.5
BTR22B18A18A	22	18	18	19	16	16	32	36	32	32	9	8.0	8.0	34	34	34	46.5	46.5	46.5
BTR22B18A22B	22	18	22	19	16	19	32	36	32	36	9	8.0	9.0	34	34	34	46.5	46.5	46.5
BTR20B20B25B	20	20	25	17	17	22	36	36	36	41	9	8.0	9.0	36	36	36	48.5	48.5	49.5
BTR25B25B16A	25	25	16	22	22	14	36	41	41	30	8	8.0	10.0	36	36	36	49.5	49.5	48.5
BTR25B25B20B	25	25	20	22	22	17	36	41	41	36	10	10.0	7.5	36	36	36	49.5	49.5	48.5
BTR28B28B10A	28	28	10	25	25	8	41	46	46	19	10	10.0	8.0	41	41	37	55.0	55.0	48.5
BTR28B28B12A	28	28	12	25	25	10	41	46	46	22	10	10.0	7.0	41	41	37	55.0	55.0	48.5
BTR28B28B15A	28	28	5	25	25	13	41	46	46	27	10	10.0	7.0	41	41	39	55.0	55.0	51.5
BTR28B28B18A	28	28	18	25	25	16	41	46	46	32	10	10.0	8.0	41	41	39	55.0	55.0	51.5
BTR28B22B22B	28	22	22	25	19	19	41	46	36	36	10	9.0	9.0	41	39	39	55.0	51.5	51.5
BTR28B28B22B	28	28	22	25	25	19	41	46	46	36	10	10.0	9.0	41	41	39	55.0	55.0	51.5
BTR25B25B30B	25	25	30	23	23	27	41	41	41	46	10	10.0	10.0	39	39	41	52.5	52.5	55.5
BTR86C22B22B	34	22	22	30	19	19	46	55	36	36	11	9.0	9.0	46	44	44	63.5	56.5	56.5
BTR86C22B86C	34	22	34	30	19	30	46	55	36	55	11	8.0	11.0	46	44	46	63.5	56.5	63.5
BTR86C28B28B	34	28	28	30	25	25	46	55	46	46	11	10.0	10.0	46	46	46	63.5	60.0	60.0
BTR86C28B86C	34	28	34	30	25	30	46	55	46	55	11	10.0	11.0	46	46	46	63.5	60.0	63.5
BTR86C86C22B	34	34	22	30	30	16	46	55	55	36	11	11.0	9.0	46	46				
BTR86C86C28B	34	34	28	30	30	25	46	55	55	46	11	11.0	10.0	46	46				

Tube Wall Thickness

A = 1.0t

B = 1.5t

C = 2.0t

* Part 'd' can be changed according to buyer's tube specification.
 Assembly instruction refers to the catalog number H-220TF.

Dimensions are reference only, subject to change.

Reducer
BR

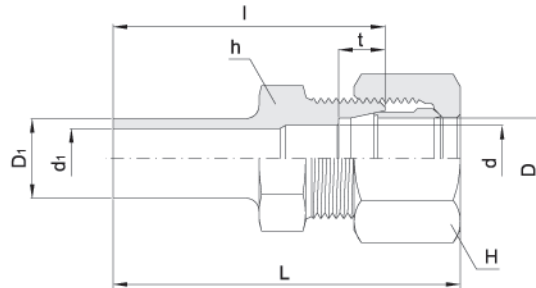

Basic Part Number	Tube O.D		*d	*d ₁	Width across flat		t	l	Approx L
	D	D ₁			h	H			
BR10PEX10	10	10	8	8	17	19	7.0	40.0	51.5
BR12PEX10	10	12	8	8	17	19	7.0	41.0	52.5
BR12PEX12	12	12	10	9	19	22	7.0	41.0	52.5
BR12PEX25	25	12	20	9	36	41	10.0	47.0	60.5
BR14PEX12-C	12	14	10	10	19	22	7.0	41.0	52.5
BR19PEX12	12	19	10	16	22	22	7.0	39.5	50.5
BR19PEX20	20	19	17	16	30	36	8.0	43.5	56.0
BR23PEX15	15	23	12	20	25	27	7.5	43.5	56.0
BR23PEX20	20	23	17	20	30	36	8.0	43.5	56.0
BR23PEX25	25	23	22	20	36	41	10.0	43.5	57.0
BR25PEX18	18	25	15	22	27	32	8.0	53.0	65.5
BR29PEX15	15	29	12	26	30	27	7.5	43.5	56.0
BR29PEX20	20	29	17	26	30	36	8.0	43.5	56.0
BR29PEX25	25	29	20	26	36	41	10.0	44.5	58.0
BR29PEX30	30	29	27	26	41	46	10.0	45.5	60.0
BR29PEX35	35	29	32	26	46	55	11.0	60.0	77.5
BR30PEX18	18	30	15	27	32	32	8.0	54.0	66.5
BR35PEX20	20	35	17	32	36	36	8.0	60.0	72.5
BR35PEX22	22	35	19	32	36	36	9.0	60.0	72.5
BR35PEX25	25	35	22	32	36	41	10.0	60.0	73.5
BR35PEX28	28	35	25	32	41	46	10.0	60.0	74.0
BR35PEX30	30	35	27	32	41	46	10.0	60.0	74.5
BR35PEX35	35	35	32	32	46	55	11.0	63.0	80.5
BR35PEX42	42	35	38	32	55	60	12.0	69.0	88.5
BR35PEX86	34	35	28	32	46	55	11.0	61.0	78.5
BR41PEX42	42	41	38	37	55	60	12.0	66.0	85.5
BR41PEX86	34	41	30	37	46	55	11.0	64.0	81.5
BR86PEX30-C	30	34	26	30	41	46	10.0	60.0	74.5

Tube Wall Thickness

- A = 1.0t
- B = 1.5t
- C = 2.0t

* Part 'd' can be changed according to buyer's tube specification.
Assembly instruction refers to the catalog number H-220TF.

Dimensions are reference only, subject to change.

Reducer
BR

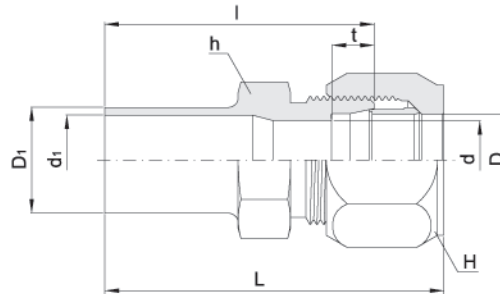

Basic Part Number	Tube O.D		*d	*d ₁	Width across flat		t	l	Approx L
	D	D ₁			h	H			
BR8TPEX8T	12.70	12.70	10.9	10.0	20.6	22.2	7.75	43.8	56.5
BR12TPEX8T	12.70	19.05	10.9	16.6	20.6	22.2	7.75	48.8	61.5
BR12TPEX12T	19.05	19.05	16.6	16.6	28.5	31.7	8.89	55.5	69.7
BR14PEX8T	12.70	12.70	11.0	11.0	20.6	22.2	7.75	44.8	57.5
BR14TPEX12T	19.05	22.20	16.6	18.9	28.5	31.7	8.89	56.5	70.7
BR14TPEX14T	22.20	22.20	18.9	18.9	31.7	34.9	8.89	55.2	68.7
BR16TPEX14T	22.20	25.40	18.9	22.1	31.7	34.9	8.89	57.2	70.7
BR16TPEX16T	25.40	25.40	22.1	22.1	34.9	38.1	10.54	58.5	75.3
BR20TPEX16T	25.40	31.80	22.1	27.6	34.9	38.1	10.54	61.5	78.3
BR20TPEX20T	31.80	31.80	27.6	27.6	46.0	50.8	10.54	63.5	81.8
BR24TPEX24T	38.10	38.10	33.9	33.9	50.0	57.1	12.32	67.3	85.6
BR8TPEX09	9.00	12.70	6.0	10.0	17.0	17.0	7.00	41.0	51.5
BR8TPEX12	12.00	12.70	9.0	10.0	19.0	22.0	7.00	41.0	52.5
BR23PEX12T	19.05	23.00	16.6	20.0	28.5	31.7	8.89	56.5	70.7
BR35PEX12T	19.05	35.00	16.6	32.0	36.0	31.7	8.89	63.5	77.7
BR35PEX16T	25.40	35.00	22.1	32.0	36.0	38.1	10.54	63.5	80.3
BR35PEX20T	31.80	35.00	27.5	32.0	46.0	50.8	10.54	63.5	81.8
BR35PEX24T	38.10	35.00	33.9	32.0	50.0	57.1	12.32	65.3	83.6
BR41PEX20T	31.80	41.00	27.5	38.0	46.0	50.8	10.54	66.5	84.8
BR41PEX24T	38.10	41.00	33.9	38.0	50.0	57.1	12.32	68.3	86.6
BR41PEX32T	50.80	41.00	46.6	38.0	65.0	73.0	12.32	72.1	93.4
BR53PEX16T	25.40	53.00	22.1	50.0	55.0	38.1	10.54	69.3	86.1
BR53PEX20T	31.80	53.00	27.5	50.0	55.0	50.8	10.54	69.3	87.6
BR53PEX24T	38.10	53.00	33.9	50.0	55.0	57.1	12.32	69.3	87.6
BR53PEX32T	50.80	53.00	46.6	50.0	65.0	73.0	12.32	73.1	94.4

*Part 'd' can be changed according to buyer's tube specification.
Assembly instruction refers to the catalog number H-220TF.

Dimensions are reference only, subject to change.